

## Duplex Filter Pi 210

Operating pressure 25 (63) bar, Nominal size up to 450

### 1. Features

#### Efficient filters for modern hydraulic systems

- Modular design
- Minimal pressure loss
- Compact design
- Visual / electrical / electronic differential pressure indication
- Threaded or SAE 4 bolt flange ports
- Switching valve on upstream side
- Ergonomic switch-over handle with safety lock and pressure compensation
- User-optimized one-hand-operation

#### Quality filters, easy to service

- Highly efficient Sm-x filter elements
- $\beta$ -rated elements per ISO 4572
- Large dirt holding capacity and high differential pressure stability providing optimal element service life

#### World-wide sales



## 2. Flow rate / pressure drop curve compl. filter

█ 190 mm<sup>2</sup>/s (25° E)  
█ 33 mm<sup>2</sup>/s (4,5° E)

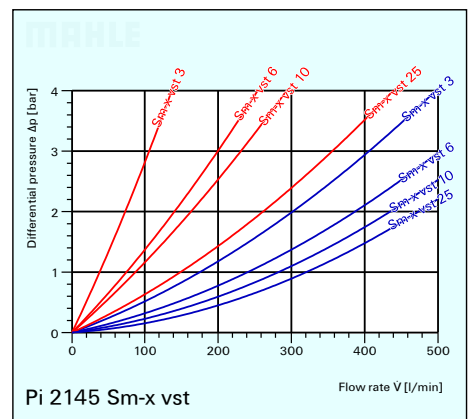
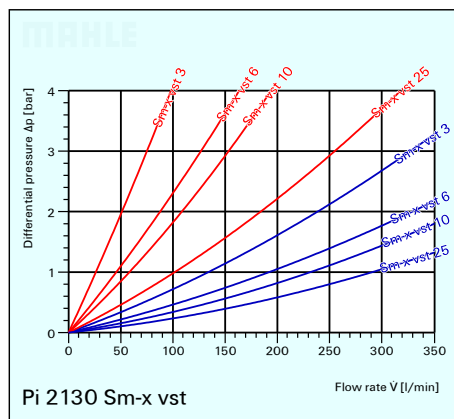
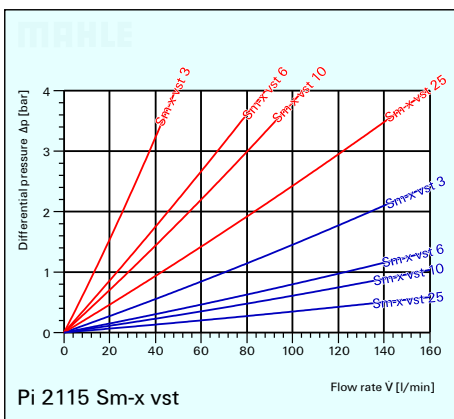
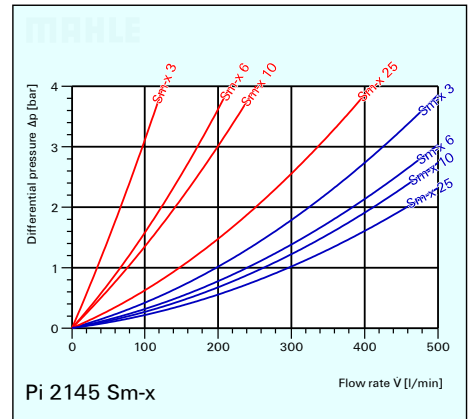
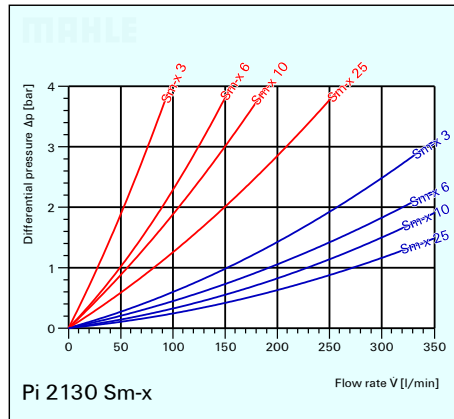
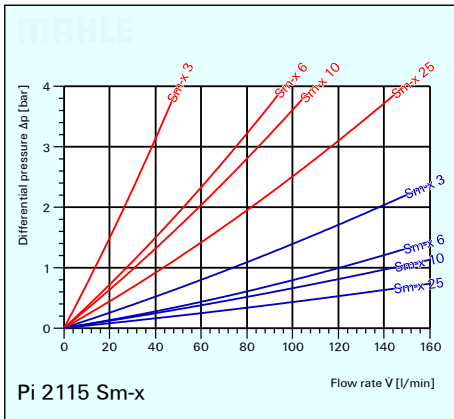
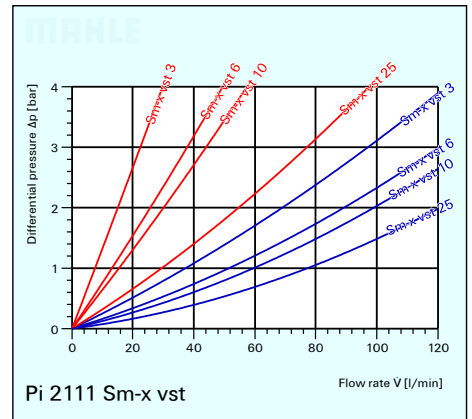
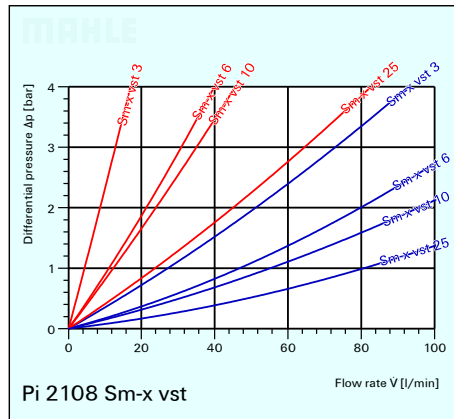
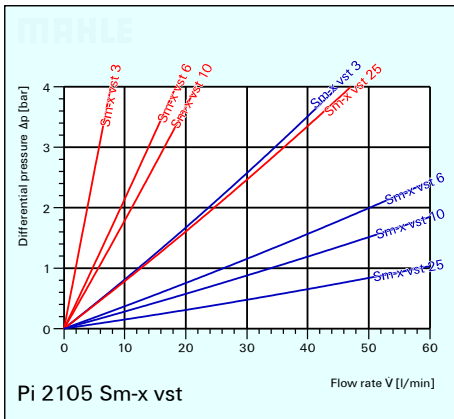
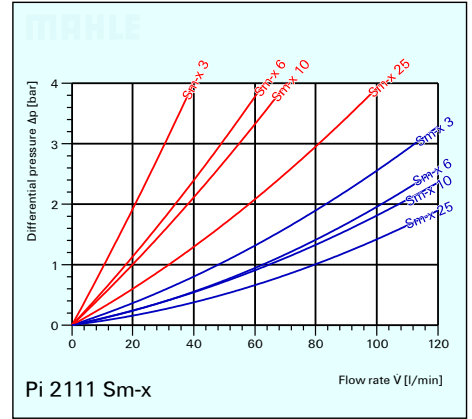
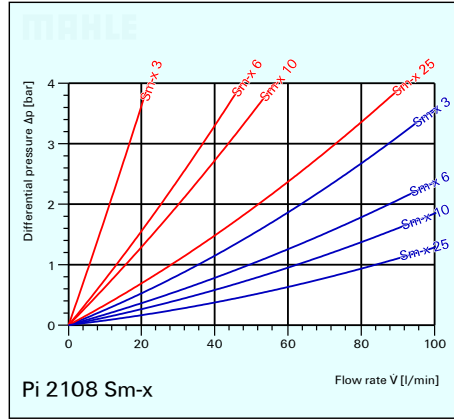
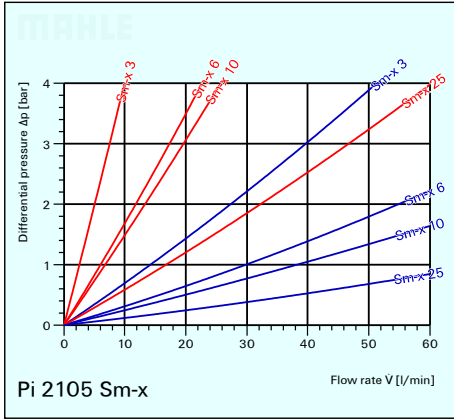

### 3. Separation characteristics

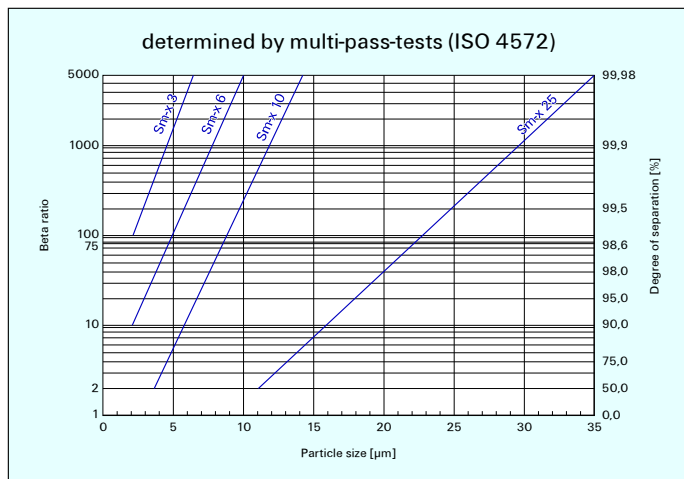

### 4. Filter performance data

tested according to ISO 4572 (multi-pass-test)

Sm-x-elements  
with  $\Delta p$  20 bar

Sm-x 3  $\beta_3 \geq 75$   
 Sm-x 6  $\beta_6 \geq 75$   
 Sm-x 10  $\beta_{10} \geq 75$   
 Sm-x 25  $\beta_{25} \geq 75$

at 7 bar differential pressure

Sm-x-vst-elements  
with  $\Delta p$  210 bar

Sm-x vst 3  $\beta_3 \geq 75$   
 Sm-x vst 6  $\beta_6 \geq 75$   
 Sm-x vst 10  $\beta_{10} \geq 75$   
 Sm-x vst 25  $\beta_{25} \geq 75$

at 16 bar differential pressure

Example for ordering filters:

Housing design with  $\dot{V} = 80$  l/min, electrical indicator  
type no. **Pi 2108-069**

order-no. **781.028.6**

+ Filter element Sm-x vst 3  
type no. **Pi 2208**

order-no. **768.020.0**

### 7. Order numbers

#### 7.1 Housing design

Order number	Type number	Nominal size NG [l/min]	① with bypass valve and visual indicator	② with bypass valve and visual/electrical indicator	③ with visual indicator	④ with visual/electrical indicator
781.021.1	Pi 2105-057	<b>50</b>				
781.022.9	Pi 2105-058					
781.023.7	Pi 2105-068					
781.024.5	Pi 2105-069					
781.025.2	Pi 2108-057	<b>80</b>				
781.026.0	Pi 2108-058					
781.027.8	Pi 2108-068					
781.028.6	Pi 2108-069					
820.408.3	Pi 2111-057	<b>110</b>				
820.409.1	Pi 2111-058					
820.410.9	Pi 2111-068					
820.411.7	Pi 2111-069					
777.457.3	Pi 2115-057	<b>150</b>				
777.456.5	Pi 2115-058					
777.455.7	Pi 2115-068					
777.454.0	Pi 2115-069					
777.453.2	Pi 2130-057	<b>300</b>				
777.452.4	Pi 2130-058					
777.451.6	Pi 2130-068					
777.450.8	Pi 2130-069					
777.449.0	Pi 2145-057	<b>450</b>				
777.448.2	Pi 2145-058					
777.447.4	Pi 2145-068					
777.446.6	Pi 2145-069					

When filter with non bypass configuration is selected, the collapse pressure of the element may not be exceeded

## 5. Test regulations

MAHLE filter elements are manufactured respectively, tested in accordance with the following international standards:

No.	Designation
ISO 2941	Hydraulic-filter elements: Verification of burst resistance
ISO 2942	Hydraulic-filter elements: Determination of fabrication integrity
ISO 2943	Hydraulic-filter elements: Verification of material compatibility with hydraulic fluids
ISO 3723	Hydraulic-filter elements: Method for testing end-cap load
ISO 3724	Hydraulic-filter elements: Verification of flow fatigue characteristics
ISO 39682	Hydraulic-filters: Evaluation of pressure drop versus flow
ISO 4572	Hydraulic-filter elements: Testing of filter performance (multi-pass-test)

## 6. Symbols

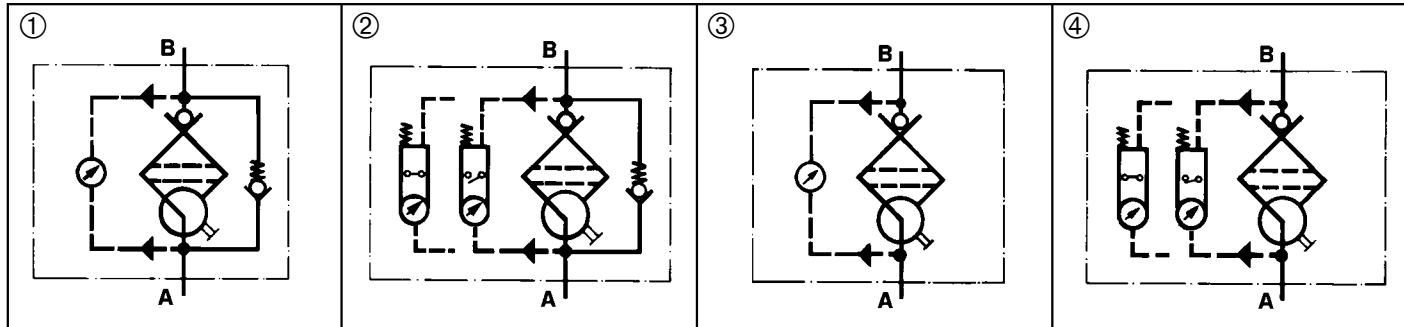

## 7.2 Filter elements\*

( ) = filter surface area [ ] = type number

Sm-x 3 Δp 20 bar	Sm-x 6 Δp 20 bar	Sm-x 10 Δp 20 bar	Sm-x 25 Δp 20 bar	Sm-x vst 3 Δp 210 bar	Sm-x vst 6 Δp 210 bar	Sm-x vst 10 Δp 210 bar	Sm-x vst 25 Δp 210 bar
(590 cm <sup>2</sup> )	(590 cm <sup>2</sup> )	(590 cm <sup>2</sup> )	(590 cm <sup>2</sup> )	(470 cm <sup>2</sup> )	(470 cm <sup>2</sup> )	(470 cm <sup>2</sup> )	(470 cm <sup>2</sup> )
768.013.5	794.350.9	768.032.5	768.044.0				
768.013.5	794.350.9	768.032.5	768.044.0	[Pi 2205]	[Pi 5205]	[Pi 3205]	[Pi 4205]
[Pi 2105]	[Pi 5105]	[Pi 3105]	[Pi 4105]	768.019.2	794.353.3	768.038.2	768.050.7
				768.019.2	794.353.3	768.038.2	768.050.7
(1150 cm <sup>2</sup> )	(1150 cm <sup>2</sup> )	(1150 cm <sup>2</sup> )	(1150 cm <sup>2</sup> )	(900 cm <sup>2</sup> )	(900 cm <sup>2</sup> )	(900 cm <sup>2</sup> )	(900 cm <sup>2</sup> )
768.014.3	794.351.7	768.034.1	768.045.7				
768.014.3	794.351.7	768.034.1	768.045.7	[Pi 2208]	[Pi 5208]	[Pi 3208]	[Pi 4208]
[Pi 2108]	[Pi 5108]	[Pi 3108]	[Pi 4108]	768.020.0	794.354.1	768.119.0	768.051.5
				768.020.0	794.354.1	768.119.0	768.051.5
(1700 cm <sup>2</sup> )	(1700 cm <sup>2</sup> )	(1700 cm <sup>2</sup> )	(1700 cm <sup>2</sup> )	(1315 cm <sup>2</sup> )	(1315 cm <sup>2</sup> )	(1315 cm <sup>2</sup> )	(1315 cm <sup>2</sup> )
768.015.0	794.352.5	768.033.3	768.046.5				
768.015.0	794.352.5	768.033.3	768.046.5	[Pi 2211]	[Pi 5211]	[Pi 3211]	[Pi 4211]
[Pi 2111]	[Pi 5111]	[Pi 3111]	[Pi 4111]	768.021.8	794.355.8	768.039.0	768.052.3
				768.021.8	794.355.8	768.039.0	768.052.3
(2350 cm <sup>2</sup> )	(2350 cm <sup>2</sup> )	(2350 cm <sup>2</sup> )	(2350 cm <sup>2</sup> )	(2010 cm <sup>2</sup> )	(2010 cm <sup>2</sup> )	(2010 cm <sup>2</sup> )	(2010 cm <sup>2</sup> )
768.016.8	795.509.9	768.035.8	768.047.3				
768.016.8	795.509.9	768.035.8	768.047.3	[Pi 2215]	[Pi 5215]	[Pi 3215]	[Pi 4215]
[Pi 2115]	[Pi 5115]	[Pi 3115]	[Pi 4115]	768.022.6	795.512.3	768.040.8	768.053.1
				768.022.6	795.512.3	768.040.8	768.053.1
(4420 cm <sup>2</sup> )	(4420 cm <sup>2</sup> )	(4420 cm <sup>2</sup> )	(4420 cm <sup>2</sup> )	(3800 cm <sup>2</sup> )	(3800 cm <sup>2</sup> )	(3800 cm <sup>2</sup> )	(3800 cm <sup>2</sup> )
768.017.6	795.510.7	768.036.6	768.048.1				
768.017.6	795.510.7	768.036.6	768.048.1	[Pi 2230]	[Pi 5230]	[Pi 3230]	[Pi 4230]
[Pi 2130]	[Pi 5130]	[Pi 3130]	[Pi 4130]	768.023.4	795.513.1	768.041.6	768.054.9
				768.023.4	795.513.1	768.041.6	768.054.9
(6540 cm <sup>2</sup> )	(6540 cm <sup>2</sup> )	(6540 cm <sup>2</sup> )	(6540 cm <sup>2</sup> )	(5600 cm <sup>2</sup> )	(5600 cm <sup>2</sup> )	(5600 cm <sup>2</sup> )	(5600 cm <sup>2</sup> )
768.018.4	795.511.5	768.037.4	768.049.9				
768.018.4	795.511.5	768.037.4	768.049.9	[Pi 2245]	[Pi 5245]	[Pi 3245]	[Pi 4245]
[Pi 2145]	[Pi 5145]	[Pi 3145]	[Pi 4145]	768.024.2	795.514.9	768.042.4	768.055.6
				768.024.2	795.514.9	768.042.4	768.055.6

\*further elements upon request

## 8. Specifications

Design:	line mounting filter
Nominal pressure:	25 bar*
Test pressure:	33 bar
Temperature range:	-10°C to +120°C (other temperature ranges on request)
Bypass opening pressure:	$\Delta p$ 3,5 bar $\pm$ 10 %
Filter head material:	GAL
Filter bowl material:	AL / St
Material of seals:	NBR / AL
Activating pressure of visual/electrical differential pressure indicator:	$\Delta p$ 2,2 bar $\pm$ 0,3 bar
Electrical data of contamination indicator:	
Maximum voltage:	230 V $\sim$ / =
Maximum current on contact:	2,5 A
Maximum contact load:	60 VA / 40 W
Inrush current:	70 VA
Type of protection:	IP 65 when inserted and secured
Contact:	bistable
Cable connection:	PG 11 $\varnothing$ 6-10

The electrical indicator function can be changed from the Normally Open position to the Normally Closed position or visa versa by inverting the electrical section.

With the inrush current of 70 VA the indicator can trigger small contactors or contactor relays.

Inductivity in the direct current may require the use of a signal eraser.

For further information and executions please see our leaflet: "Contamination indicators".

Filters compatible with standard mineral oils.

Please contact us in case of using other media.

**\*The housings Pi 2105, Pi 2108 and Pi 2111 are approved for 63 bar operating pressure (test pressure 82 bar).**

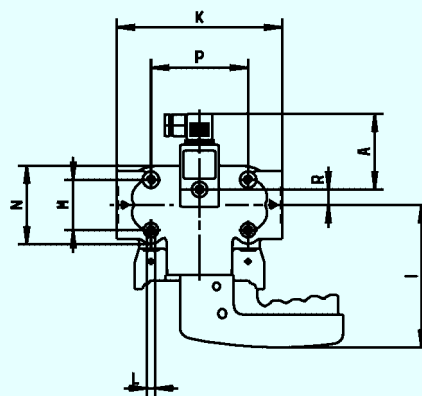
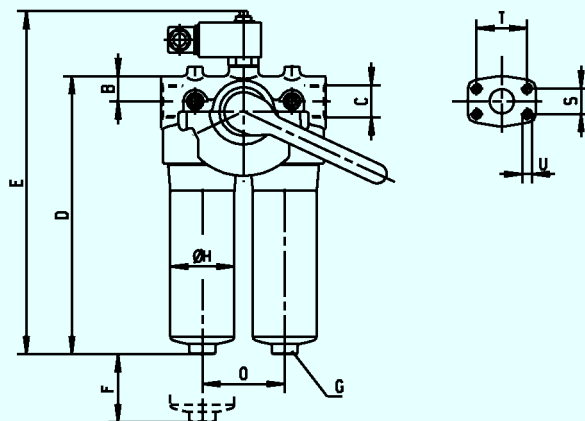

## 9. Dimensions

All dimensions (except "C") in mm

Dimension Type	A	B	C	D	E	F	G	H	I	K	L	M	N	O	P	R	Weight [kg]
Pi 2105	78	38	G 1*	200	258	80	SW 27	66	139	168	M 8 x 16	52	81	85	100	16	2,6
Pi 2108	78	38	G 1*	276	334	80	SW 27	66	139	168	M 8 x 16	52	81	85	100	16	2,9
Pi 2111	78	38	G 1*	358	416	80	SW 27	66	139	168	M 8 x 16	52	81	85	100	16	3,3
Pi 2115	78	40	G 1½*	269	327	110	SW 32	109	165	280	M 10 x 20	62	140	140	210	19	7,1
Pi 2130	78	40	G 1½*	386	444	110	SW 32	109	165	280	M 10 x 20	62	140	140	210	19	8,0
Pi 2145	78	40	G 1½*	501	559	110	SW 24	109	165	280	M 10 x 20	62	140	140	210	19	16,0

\*SAE flange connections (3000 PSI) on request

## 10. Installation, Operating and Servicing Instructions

### 10.1 Filter installation

Install filter in accordance with the identified flow direction. The filter head is provided with threaded holes for mounting the filter. Ascertain that the required removal height is provided so that the filter element and the filter bowl can be removed.

Preferably the filter should be installed with the filter bowl pointing down.

The contamination indicator must be well visible.

### 10.2 Connecting the electrical contamination indicator

The electrical indicator is connected via a 2-pole appliance plug according to DIN 43650 with poles marked 1 and 2.

The electrical section can be inverted to change from Normally Open position to Normally Closed position or visa versa.

### 10.3 When must the filter element be replaced?

1. During cold starts, the indicator may give a warning signal. Depress the red button of the visual indicator once again only after operating temperature has been reached. If the red button immediately pops out again and/or the electrical signal has not switched off after reaching operating temperature, the filter element must be replaced after the end of the shift.
2. Please always ensure that you have original MAHLE replacement elements in stock: disposable elements (Sm-x) cannot be cleaned.

### 10.4 Element replacement

**Note:** The contamination indicator monitors the filter side in operation, which is identified by the position of the switching lever catch. The flow transfer valve must be switched prior to filter servicing. Now the signal of the contamination indicator is cancelled and the red button can be depressed again.

1. Operate and hold pressure equalizing lever located in the switching lever. Swivel switching lever. Engage the catch. Place trough or drip pan underneath to collect leaking oil.
2. Loosen vent screw of the filter side not in use by 2–3 turns; maximum back out against safety stop.
3. Unscrew filter bowl by rotating same counterclockwise and clean with a suitable medium.
4. Remove filter element with a side-to-side motion.
5. Check O-ring on the filter bowl and the spigot for damage. Replace, if necessary.
6. Make sure that the part number on the spare element corresponds with the part number on the filter label. Open the plastic bag and push element over the spigot in the filter head. Now remove plastic bag.
7. Complete installation by screwing on the bowl, turning clockwise until it comes to a full stop. Back off the bowl  $\frac{1}{8}$  to  $\frac{1}{2}$  turn.
8. To refill the filter chamber, operate only the pressure equalizing lever long enough for the medium to emerge bubble-free from the vent bore.
9. Tighten vent screw. Check filter for leaks by operating the pressure equalizing lever once again.

Subject to technical alteration.

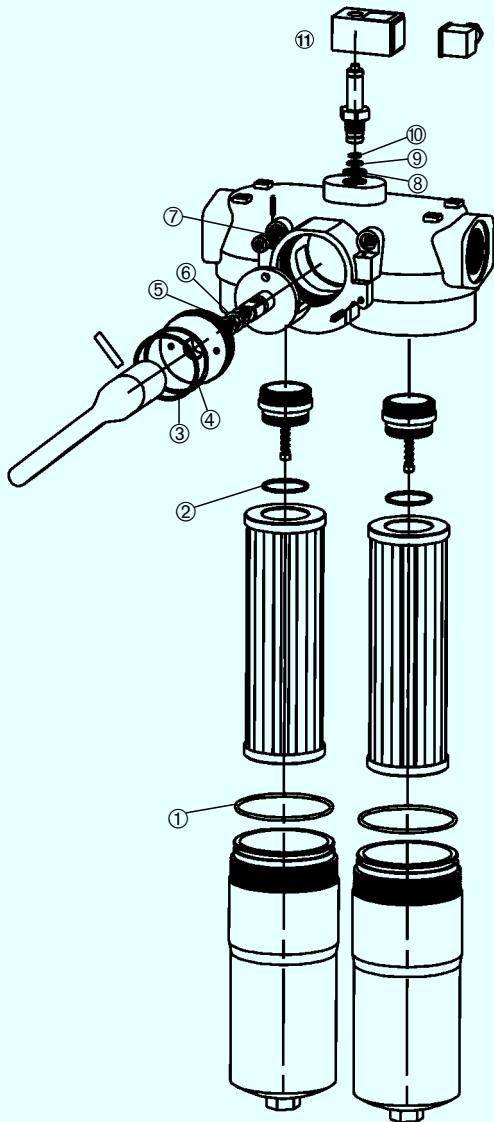

## 11. Spare parts list

Pos.	Type number/housing		
	Pi 2105–Pi 2111		Pi 2115–Pi 2145
① to ⑦	Seal kit NBR 976.127.1 FPM 976.128.9 EPDM 976.129.7	Seal kit NBR 976.123.0 FPM 976.124.8 EPDM 976.125.5	
⑧ to ⑩	Seal kit for contamination indicator NBR 776.030.9 FPM 776.031.7 EPDM 776.032.5		
⑪	Contamination indicator visual 766.997.1 Pis 3098 / 2,2	electrical 766.994.8 Pis 3097 / 2,2	electrical upper part only 753.655.0

Please return filter for sealing replacement of switch-over unit!

# MAHLE

MAHLE Filtersysteme GmbH

Bereich Industriefilter · Schleifbachweg 45 · D-74613 Öhringen · Postfach 13 09 · D-74603 Öhringen  
Telefon (0 79 41) 67-0 · Telefax (0 79 41) 67-429 · Internet: <http://www.mahle.com> · E-mail: [ub2.industrie@mahle.com](mailto:ub2.industrie@mahle.com)